

SS-W100H-RF Series (Wi-Fi) Wireless Floor Heating Control Box

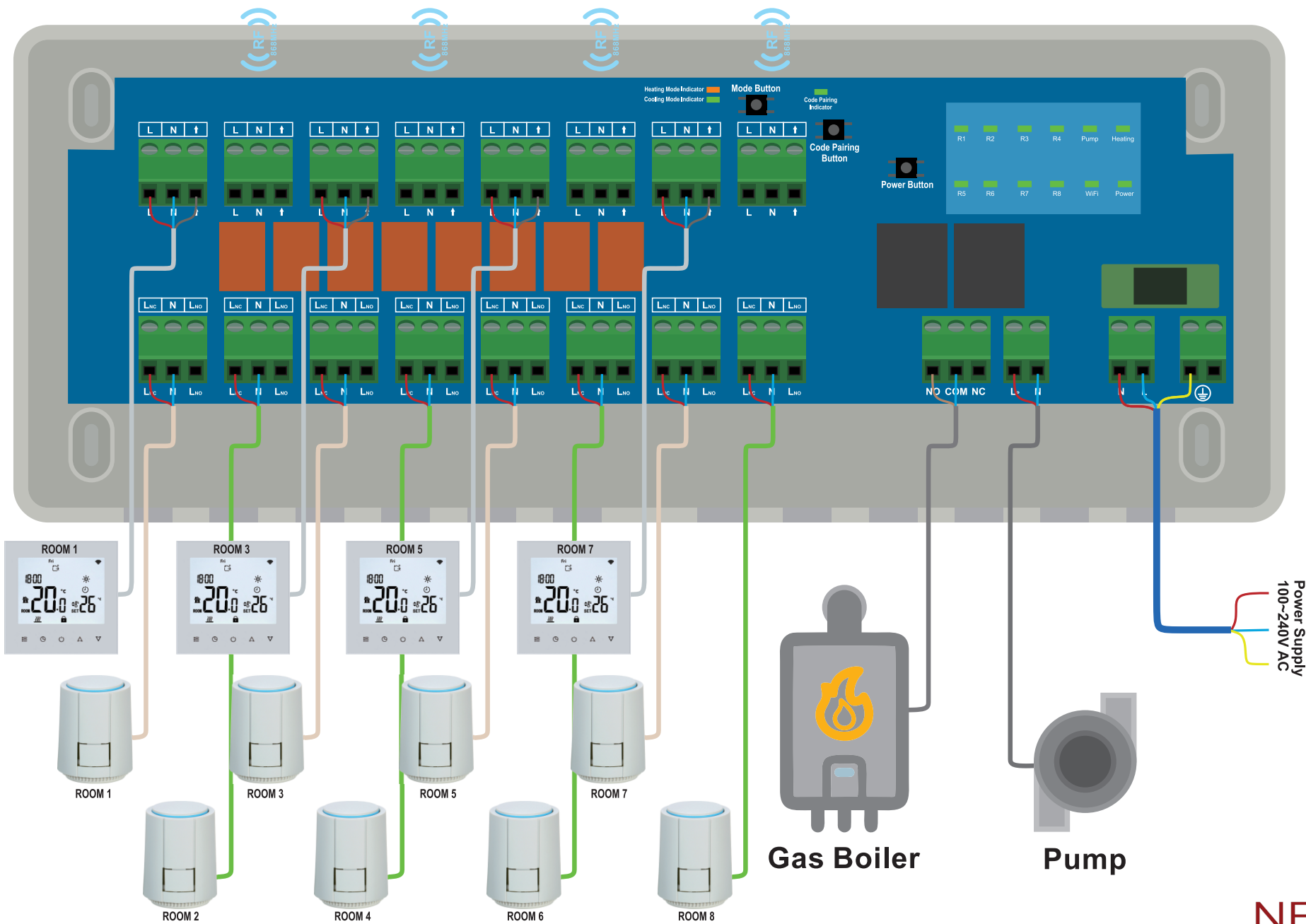

Electrical wiring diagram

(SS-W100H-RF Series)

Thermostat Connection

(Thermostat to the control box)

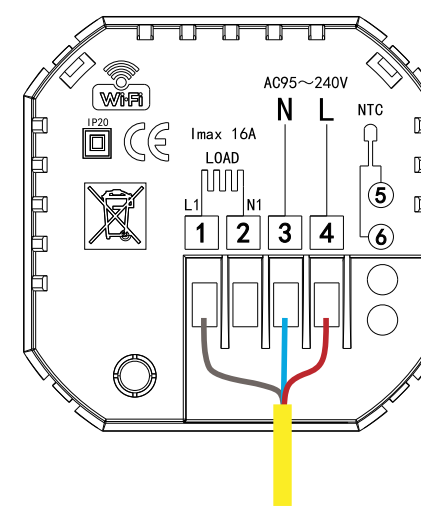
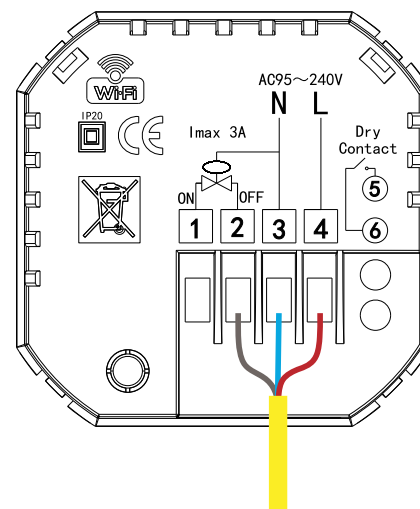
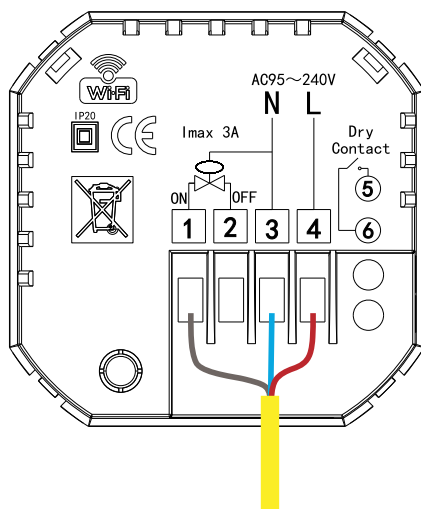

Control Box Connection

(Thermostat to the control box)

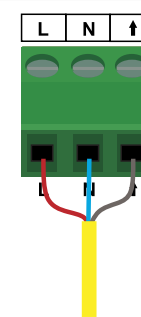
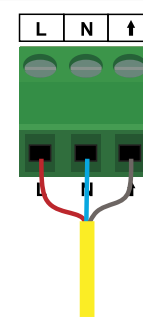
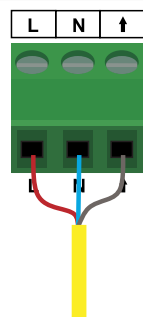

Actuator Connection

(Please note that each output can have up to 5 actuators connected in parallel at the same time.)

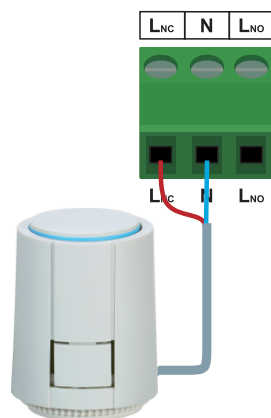

NC
Actuator

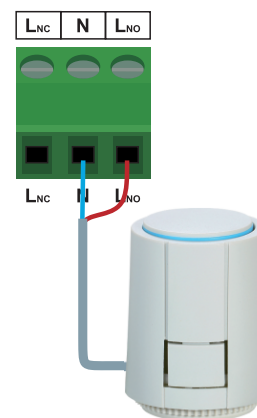

NO
Actuator

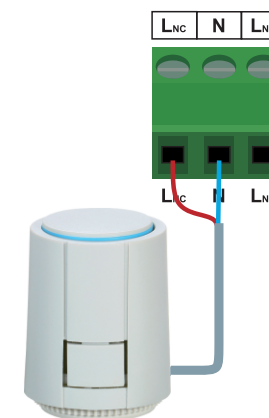

NC
Actuator